

— Ifi's —
SAM80

Collection

DESIGN IFI R&D DEPT.





— Ifi's —
SAM80

Applications

SERVIZI / SERVICES
 AUSFÜHRUNGEN / SERVICIOS



Pastry

Pasticceria
 Pâtisserie
 Konditorei
 Pastelería



*Cold Snack -
 Dry Heat*

Snack Freddo - Caldo Secco
 Snack Froids - Chaleur Sèche
 Kalter Snack - Trocken Warm
 Snack Frio - Calor Seco



Gelato

Gelato
 Gelato
 Gelato
 Gelato



Praline - Pastry

Pralineria - Pasticceria
 Pralines - Pâtisserie
 Pralinen - Konditorei
 Pralinería - Pastelería



Dry Heat

Caldo Secco
 Chaleur Sèche
 Trocken Warm
 Calor Seco



4 Seasons

4 Stagioni
 4 Saisons
 4 Jahreszeiten
 4 Estaciones



Cold Snack

Snack Freddo
 Snacks Froids
 Kalter Snack
 Snack Frio







1A-1B.
Stainless steel cakes tray
 Vasca porta torte
 Cuve porte-gâteaux
 Tortenträger
 Cuba porta tartas
 L 500 mm / 19.68"

2A-2B.
Gelato on a stick holder
 Porta gelato su stecco
 Support pour gelato sur bâton
 Gelato-Ständer
 Porta-gelato en polo
 Pan / Vaschetta / Bac
 Gelatowanne / Cubeta
 360x250 mm / 14.17"x9.84"
 360x165 mm / 14.17"x6.50"

3A-3B.
Single portions
 Monoporzioni
 Monoportions
 Einzelportionen
 Monoporciones
 360x330 mm / 14.17"x12.99"
 360x165 mm / 14.17"x6.50"





Gelato

GELATO / GELATO / GELATO / GELATO





Hi-performance Closure System

SISTEMA DI CHIUSURA HCS / SYSTÈME DE FERMETURE HCS / VERSCHLUSSSYSTEM „HCS“ / SISTEMA DE CIERRE HCS



Hi-performance Closure System

[PLAY VIDEO](#)



Thanks to the reduced number of defrosts, and the reduced contacts between gelato and atmosphere, the gelato tastes and looks better. HCS system reduces electricity consumption, with benefits for the environment, costs, and the condensing unit lifetime. Beyond displaying gelato, the display case can work as a chiller cabinet.

Grazie al ridotto numero di sbrinamenti e ai limitati contatti del gelato con l'ambiente esterno, il gelato è migliore nelle caratteristiche organolettiche e nell'aspetto. Il sistema HCS riduce il consumo di energia elettrica, con benefici per l'ambiente, i costi di gestione e la durata del compressore. Oltre a esporre il gelato, la vetrina chiusa può fungere da armadio refrigerato.

Grâce à la réduction du nombre de dégivrages et au contact limité du gelato avec l'environnement extérieur, le gelato offre de meilleures propriétés organoleptiques et visuelles. Le système HCS réduit la consommation d'énergie électrique, dont l'environnement, les coûts de gestion et la durée de vie du compresseur tirent bénéfice. Outre sa fonction de présentoir à gelato, la vitrine fait office d'armoire réfrigérante.

Durch die geringere Anzahl der Abtauvorgänge und den begrenzten Kontakt des Gelatos mit der Außenluft weißt das Gelato bessere organoleptische und optische Eigenschaften auf. Das HCS-System reduziert den Stromverbrauch, was sich positiv auf die Umwelt, die Betriebskosten und die Lebensdauer des Kompressors auswirkt. Neben der Funktion der Präsentation des Gelatos kann die geschlossene Vitrine auch als Kühlschrank verwendet werden.

Gracias al reducido número de desescarches y a los limitados contactos del gelato con el ambiente exterior, el gelato es mejor en cuanto a las características organolépticas y al aspecto. El sistema HCS reduce el consumo de energía eléctrica, con beneficios para el medio ambiente, los costes de gestión y la durabilidad del compresor. Además de exponer el gelato, la vitrina cerrada puede funcionar como armario refrigerado.

Technical details

DETTAGLI TECNICI / DONNÉES TECHNIQUES / TECHNISCHE DETAILS / CARACTERÍSTICAS TÉCNICAS



Watersave Scoop-Washer



1. Gelato visibility - Visibilità gelato / Visibilité gelato / Sichtbarkeit des Gelatos / Visibilidad gelato; **2. Watersave scoop washer** - Lavaporzionateur *watersave* / Lave-portionneuse *watersave* / *Watersave* Eisportionierspüler / Lavaporcionador *watersave*; **3. Streamlined scoop washer with tap** - Lavaporzionateur carenato con rubinetto / Lave-portionneuse caréné avec robinet / Verkleideter Eisportionierspüler mit Wasserhahn / Lavaporcionador carenado con grifo; **4. Continuous-flow streamlined scoop washer** - Lavaporzionateur carenato a flusso continuo / Lave-portionneuse caréné à débit continu / Verkleideter Eisportionierspüler mit Dauerfluss / Lavaporcionador carenado de flujo continuo. **5./6. Heights: 1200 and 1350 mm (47.24" and 53.15")** - Altezza: 1200 e 1350 mm. / Hauteurs: 1200 et 1350 mm. / Höhen: 1200 und 1350 mm. / Alturas: 1200 y 1350 mm.; **7. Pyrolytic, heated and tempered front glass, easy to open downwards** - Vetro frontale pirolitico, riscaldato, temperato, con facile apertura verso il basso. / Vitre frontale pyrolytique, chauffée et trempée à ouverture facile vers le bas / Pyrolytische, gewärmte, gehärtete Frontscheibe mit einfacher Öffnung nach unten / Cristal frontal pirolítico, calentado y templado, de fácil apertura hacia abajo; **8. LED lighting** - Illuminazione a LED / Éclairage à LED / LED-Beleuchtung / Iluminación con LED;

Front Glass Easy Opening



Condensing Unit Easy Cleaning



9. Temperature repeater on customer side and non-structural steel aesthetic side (3 mm / 0.12" thick-painted with epoxy powders) - Ripetitore temperatura lato cliente e fianco estetico non strutturale in acciaio (sp. 3 mm - verniciato con polveri epossidiche) / Répétiteur de température côté client et joue esthétique en acier hors structure (ép. 3 mm - peint avec des poudres époxy) / Wiederholung der Temperaturanzeige auf der Kundenseite und optisches, nicht tragendes Seitenteil aus Stahl (St. 3 mm - mit Epoxidpulver lackierten) / Repetidor de temperatura en el lado del cliente y lateral estético de acero no estructural (esp. 3 mm - barnizado con polvos epoxi); **10. Tempered float glass top which stays horizontal without any need for intermediate supports: a large surface for cups, toppings and accessories.** - Vetro float superiore temperato che rimane in posizione orizzontale senza bisogno di sostegni intermedi: un ampio piano d'appoggio per coppette, toppings, e accessori. / Vitre float supérieure trempée qui reste en position horizontale sans besoin de support intermédiaire: grand plan d'appui pour les pots, garnitures et accessoires. / Oberes gehärtetes Floatglas, das ohne Mittelstützen in waagrechter Stellung bleibt: eine große Ablagefläche für Eisbecher, Toppings und Zubehör. / Cristal float superior templado que permanece en posición horizontal sin necesidad de soportes intermedios: una amplia repisa de apoyo para tarrinas, toppings y accesorios. **11./12. Optional flush-mounted wheels. The foot acts as a brake** - Ruote optional a scomparsa. Il piedino funge da freno / Roues en option escamotables. Le pied fait office de frein / Versenkbare Räder als Sonderausstattung. Der Fuß dient als Bremse. / Ruedas opcionales escamoteables. Los pies hacen de freno. **13. Very easy to clean condenser** - Estrema facilità di pulizia del condensatore. / Très grande facilité de nettoyage du condensateur / Äußerst einfache Reinigung des Kondensators / Condensador sumamente fácil de limpiar.



4 Seasons

4 STAGIONI / 4 SAISONS / 4 JAHRESZEITEN / 4 ESTACIONES

4 Seasons: from Gelato to Pastry

[PLAY VIDEO](#)

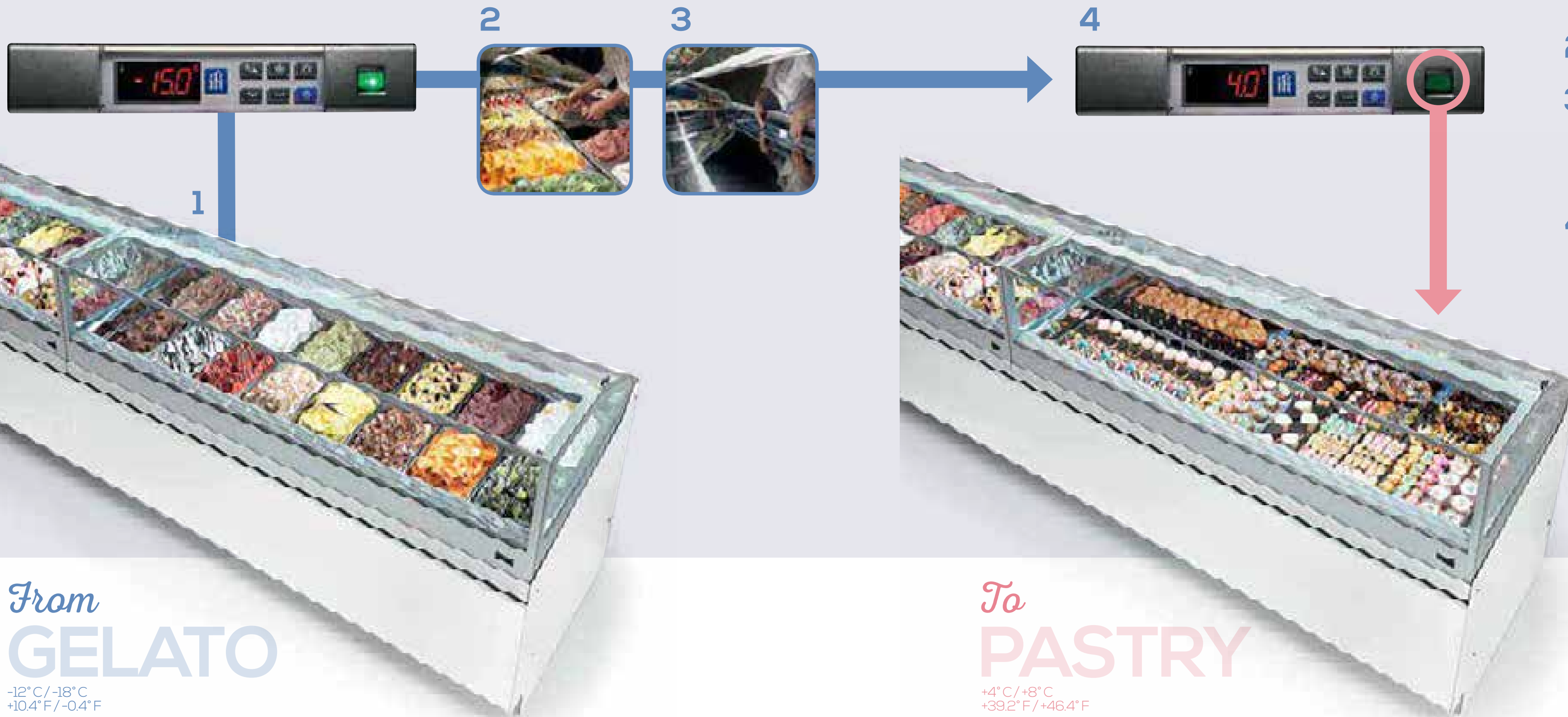

- 1 GELATO SETTING: -15°C / +5°F**
 FUNZIONE GELATO: -15°C
 FONCTION GELATO: -15°C
 FUNKTION GELATO: -15°C
 FUNCIÓN DE GELATO: -15°C
- 2 REMOVE THE PANS**
 TOGLIERE LE VASCHE / ENLEVER
 LES BACS / DIE GELATO-WANNEN
 HERAUSZIEHEN / SACAR LAS CUBETAS
- 3 INSERT THE STAINLESS STEEL
 DISPLAY TOP (OPTIONAL)**
 INSERIRE IL VASSOIO ESPOSITIVO
 (OPTIONAL) / INSÉRER LE PLAN
 D'EXPOSITION EN ACIER INOXYDABLE
 (EN OPTION) / DIE AUSSTELLFLÄCHE
 (ALS OPTION) AUS ROSTFREIEM
 EDELSTAHL EINSETZEN / INTRODUCIR
 EL PLANO DE EXPOSICIÓN INOXIDABLE
 (OPCIONAL).
- 4 CLICK THE GREEN BUTTON ONCE TO
 SWITCH IT FROM ON TO OFF; THAT WAY
 THE DISPLAY CASE WILL AUTOMATICALLY
 CHANGE TO THE PASTRY SETTING
 (+ 4°C / +39.2°F).**
 CLICCARE UNA SOLA VOLTA IL PULSANTE
 VERDE, CHE DA ACCESSO DIVENTERÀ
 SPENTO: IN QUESTO MODO LA VETRINA
 PASSERÀ AUTOMATICAMENTE ALLA
 FUNZIONE PASTICCERIA (+ 4°C).
 APPUYER UNE SEULE FOIS SUR LE
 BOUTON VERT ; ALLUMÉ, IL S'ÉTEINT:
 DE LA SORTE, LA VITRINE PASSE
 AUTOMATIQUEMENT À LA FONCTION
 PÂTISSERIE (+4°C).
 NUR EINMAL AUF DIE GRÜNE TASTE
 KLICKEN, DIE VON EIN AUF AUS WECHSELT:
 AUF DIESE WEISE SCHALTET DIE VITRINE
 AUTOMATISCH AUF DIE FUNKTION
 KONDITOREI (+ 4 °C).
 HAGA CLIC UNA SOLA VEZ EN EL BOTÓN
 VERDE, QUE PASARÁ DE ACTIVADO A
 DESACTIVADO: DE ESTE MODO, LA VITRINA
 PASARÁ AUTOMÁTICAMENTE A LA FUNCIÓN
 DE PASTELERÍA (+4 °C).

From
GELATO

-12°C / -18°C
+10.4°F / -0.4°F

To
PASTRY

+4°C / +8°C
+39.2°F / +46.4°F



ONLY
1003 MM
39.49"

2125

83.66"

12+12 / 8+8

Side panels not included: 1 side panel 3 mm / 0.12"

Misure senza fianchi: 1 fianco sp. 3 mm / Mesures sans joues: 1 joue - 3 mm d'épaisseur
Maße ohne Endseitenteilen: 1 Endseitenteil 3 mm / Medidas sin lados: 1 lado esp. 3 mm



1625

63.98"

9+9 / 6+6



1125

44.29"

6+6 / 4+4

All the SAM80 gelato modules (1125, 1625, 2125) are available with high straight glass (VAD) and low straight glass (VBD) frames - see Sections pp 46-47.

Tutti i moduli SAM80 gelato (1125, 1625, 2125) sono disponibili con i vetri alti diritti (VAD) e vetri bassi diritti (VBD) - cfr. Sezioni pp 46-47. / Tous les modules SAM80 gelato (1125, 1625, 2125) sont disponibles avec structures vitrées en vitres hautes droites (VAD) et vitres basses droites (VBD) - voir Sections p. 46-47. / Alle Module SAM80 Gelato (1125, 1625, 2125) sind mit den Glasregalen mit hohen geraden Scheiben (VAD) und mit niedrigen geraden Scheiben (VBD) erhältlich - siehe Abschnitte auf S. 46-47. / Todos los módulos SAM80 gelato (1125, 1625, 2125) están disponibles con las campanas de cristal con vidrios altos rectos (VAD) y con vidrios bajos rectos (VBD) - cfr. Secciones pág. 46-47.





Shelf with LED lighting.
Transparent food-grade
Plexiglas shelf holder.

Mensola con illuminazione
a LED. Reggimensola in
plexiglas trasparente e
idoneo all'uso alimentare.

Étagère dotée d'éclairage
à LED. Support d'étagère
en plexiglas transparent
et propre à la consommation
alimentaire.

Ablage mit LED-Beleuchtung.
Ablagenhalterung aus
transparentem,
lebensmittelechtem Plexiglas.

Repisa con iluminación
con LED. Soporte de la repisa
de plexiglás transparente,
apto para uso alimentario.

**812 mm / 31.97" deep display
surface perfect for holding
600x400 mm / 23.62"x15.75"
trays in depth.**

Piano espositivo profondo
812 mm perfetto per
ospitare in profondità
vassoi 600x400 mm.

Plan d'exposition de 812 mm
de profondeur, idéal pour
accueillir jusqu'au fond des
plateaux de 600x400 mm.

812 mm tiefe
Ausstellungsfläche, die sich
perfekt für die Aufnahme von
600x400 mm Tablettis eignet.

Tablero de exposición
de 812 mm de profundidad,
perfecto para exponer
bandejas de 600x400 mm.





Pastry

PASTICCERIA / PÂTISSERIE / KONDITOREI / PASTELERÍA

muffins



donuts

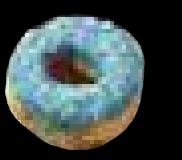

macarons





6 position-Adjustable Trays



Pastry

PASTICCERIA / PÂTISSERIE / KONDITOREI / PASTELERÍA

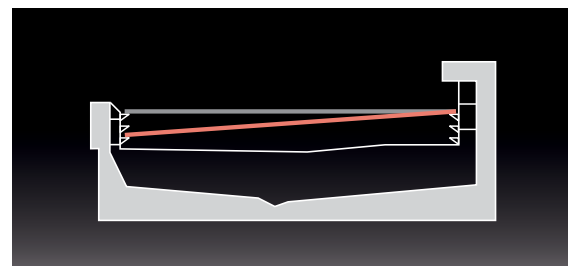

The refrigerated display surface has removable polished stainless steel surfaces that can be placed in 6 different positions: 3 horizontal positions with a pitch of 20 mm / 0.79"; 2 positions at an angle of 1.5° and one position at an angle of 3°.

Il piano espositivo refrigerato è costituito da piani amovibili in acciaio inox lucido collocabili in 6 diverse posizioni: 3 posizioni orizzontali con passo di 20 mm; 2 posizioni inclinate di 1,5° e una posizione inclinata di 3°.

Le plan d'exposition réfrigéré est constitué de plans amovibles en acier inoxydable brillant qu'il est possible de placer à 6 positions différentes: 3 positions horizontales à un pas de 20 mm; 2 positions inclinées à 1,5° et une position inclinée à 3°.

Die gekühlte Ausstellungsfläche besteht aus herausnehmbaren Flächen aus poliertem Inox-Stahl, die in 6 unterschiedliche Stellungen eingesetzt werden können: 3 waagrechte Stellungen mit einem Abstand von 20 mm; 2 Schrägstellungen mit einem Winkel von 1,5° und eine Schrägstellung mit einem Winkel von 3°.

El tablero de exposición refrigerado está formado por tableros amovibles de acero inoxidable brillante que pueden colocarse en 6 posiciones diferentes: 3 posiciones horizontales con paso de 20 mm; 2 posiciones inclinadas 1,5° y una posición inclinada 3°.



Pastry: glass frame configurations

PASTICCERIA: CONFIGURAZIONI CASTELLI VETRO / PÂTISSERIE : AGENCEMENTS EN STRUCTURES VITRÉES
KONDITOREI: KONFIGURATIONEN DER GLASREGALE / PASTELERÍA: CONFIGURACIONES CAMPANAS DE CRISTAL



VAD

High straight glasses

Vetri alti dritti / Vitres hautes droites /
Hohe gerade Scheiben / Vidrios altos rectos

1 shelf

1 mensola / 1 étagère / 1 Ablage / 1 repisa



VAD

High straight glasses

Vetri alti dritti / Vitres hautes droites /
Hohe gerade Scheiben / Vidrios altos rectos

1 shelf + 1 shelf (optional)

1 mensola + 1 mensola (optional) / 1 étagère + 1 étagère
(en option) / 1 Ablage + 1 Ablage (als Option) / 1 repisa
+ 1 repisa (opcional)



VBD

Low straight glasses

Vetri bassi dritti / Vitres basses droites /
Niedrige gerade Scheiben / Vidrios bajos rectos



VBD

Low straight glasses

Vetri bassi dritti / Vitres basses droites
Niedrige gerade Scheiben/ Vidrios bajos rectos

1 shelf (optional)

1 mensola (optional) / 1 étagère (en option)
1 Ablage (als Option) / 1 repisa (opcional)

All the SAM80 pastry modules (1125, 1625, 2125 / 44.29", 63.97", 83.66") are available with all the glass frames – see Sections pp 46-47.

Tutti i moduli SAM80 pasticceria (1125, 1625, 2125) sono disponibili con tutti i castelli vetro - cfr. Sezioni pp 46-47. / Tous les modules SAM80 pâtisserie (1125, 1625, 2125) sont disponibles avec toutes les structures vitrées - voir Sections p. 46-47. / Alle Module SAM80 Konditorei (1125, 1625, 2125) sind mit allen Glasregalen erhältlich - siehe Abschnitte auf S. 46-47. / Todos los módulos SAM80 pastelería (1125, 1625, 2125) están disponibles con todas las campanas de cristal - cfr. Secciones pág. 46-47.

Sam80 Refrigerated Shelves

SAM80 MENSOLE REFRIGERATE / SAM80 ÉTAGÈRES RÉFRIGÉRÉES / SAM80 KÜHLABLAGEN / SAM80 REPISAS REFRIGERADAS



PASTRY/SNACK DISPLAY CASE H. 1350 (53.15") WITH REFRIGERATED SHELVES

Glass top heated by means of screen-printed heating elements. Equipped with two 240mm / 9.45"-deep refrigerated shelves. The shelves are fitted with LED lights and supported by food-grade transparent Plexiglas supports. The closing system on the operator side consists of 8mm / 0.31"-thick alveolar Plexiglas sliding doors with hermetic side seals and chrome-plated metal handles.

VETRINA PASTICCERIA SNACK VENTILATA H 1350 CON MENSOLE REFRIGERATE

Tetto in vetro riscaldato per mezzo di resistenze serigrafate. In dotazione due mensole refrigerate profonde 240 mm. Le mensole sono dotate di illuminazione LED e sono sorrette da sostegni in Plexiglas trasparente idoneo all'uso alimentare. Sistema di chiusura lato operatore con ante scorrevoli in plexiglas alveolare, spessore 8 mm, con guarnizioni laterali a tenuta ermetica e maniglie in metallo cromato.

VITRINE PÂTISSERIE/SNACK VENTILÉE H 1350 AVEC ÉTAGÈRES RÉFRIGÉRÉES

Toit en verre chauffé par des résistances sérigraphiées. Fourniture de deux étagères réfrigérées de 240 mm de profondeur. Les étagères sont dotées d'éclairage à LED et sont soutenues par des supports en plexiglas transparent adaptés à l'usage alimentaire. Système de fermeture côté opérateur à battants coulissants en plexiglas alvéolaire, de 8 mm d'épaisseur, avec joints latéraux à étanchéité hermétique et poignées en métal chromé.

UMLUFTGEKÜHLTE KONDITOREI/SNACKVITRINE H 1350 MIT KÜHLABLAGEN

Das Dach wird von aufgedruckten Widerständen gewärmt. Zur Ausstattung gehören zwei 240 mm tiefe Kühlblagen. Die gekühlten Ablagen sind mit LED-Beleuchtung ausgestattet und werden von Stützen aus durchsichtigem, lebensmittelechtem Plexiglas getragen. Schließsystem auf der Bedienerseite mit Schiebetüren aus 8 mm starken Plexiglas-Stegplatten mit seitlichen isolierenden Dichtungen und Griffe aus verchromtem Metall.

VITRINA PASTELERÍA/SNACKS VENTILADA (Al. 1350) CON REPISAS REFRIGERADAS

Techo de vidrio calentado mediante resistencias serigrafadas. Está equipada con dos repisas refrigeradas de 240 mm de profundidad. Las repisas cuentan con iluminación LED y se sujetan con soportes de plexiglas transparente, adecuados para un uso alimentario. Sistema de cierre en el lado del operador con puerta corredera de plexiglas alveolar, un espesor de 8 mm, protecciones laterales de sellado hermético y manillas de metal cromado.





Praline - Pastry

PRALINERIA - PASTICCERIA / PRALINES - PÂTISSERIE
PRALINEN - KONDITOREI / PRALINERÍA - PASTELERÍA

pralines

praline / pralines
Pralinen / pralinería





Praline - Pastry

PRALINERIA - PASTICCERIA / PRALINES - PÂTISSERIE
PRALINEN - KONDITOREI / PRALINERÍA - PASTELERÍA

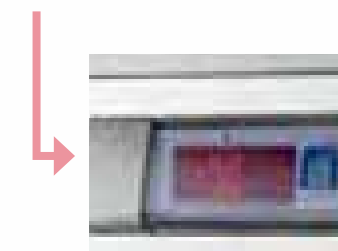
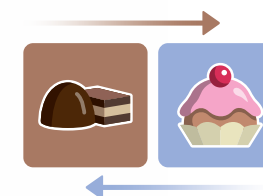

TEMPERATURE-RELATIVE HUMIDITY
Temperatura-Umidità Relativa
Température-Humidité Relative
Temperatur-Relative Luftfeuchtigkeit
Temperatura-Humedad Relativa





Cold Snack

SNACK FREDDO / SNACKS FROIDS / KALTER SNACK / SNACK FRÍO



Cold Snack

SNACK FREDDO / SNACKS FROIDS / KALTER SNACK / SNACK FRÍO





Cold Snack - Dry Heat

SNACK FREDDO - CALDO SECCO / SNACK FROIDS - CHALEUR SÈCHE
 KALTER SNACK - TROCKEN WARM / SNACK FRIO - CALOR SECO

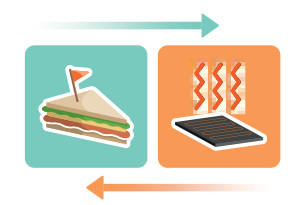



Dry Heat

CALDO SECCO / CHALEUR SÈCHE / TROCKEN WARM / CALOR SECO



1350

53.15"

VAD

High straight glasses
Vetri alti dritti
Vitres hautes droites
Hohe gerade Scheiben
Vidrios altos rectos



1200

47.24"

VBD

Low straight glasses
Vetri bassi dritti
Vitres basses droites
Niedrige gerade Scheiben
Vidrios bajos rectos



Technical details

DETTAGLI TECNICI / DONNÉES TECHNIQUES / TECHNISCHE DETAILS / CARACTERÍSTICAS TÉCNICAS



HEATED SHELF / MENSOLA RISCALDATA / ÉTAGÈRE CHAUFFÉE / BEHEIZTE ABLAGE / REPISA CALENTADA



- 1/2. Work surface extension with total depth of 150 mm / 5.91" - all applications.**
 Estensione piano lavoro per una profondità totale di 150 mm - tutti i servizi.
 Rallonge du plan de travail sur une profondeur totale de 150 mm - tous les services.
 Ablage mit LED-Beleuchtung. Ablagenhalterung aus transparentem, lebensmittelechtem Plexiglas - alle Dienstleistungen.
 Extensión del tablero de trabajo para obtener una profundidad total de 150 mm - todos los servicios.

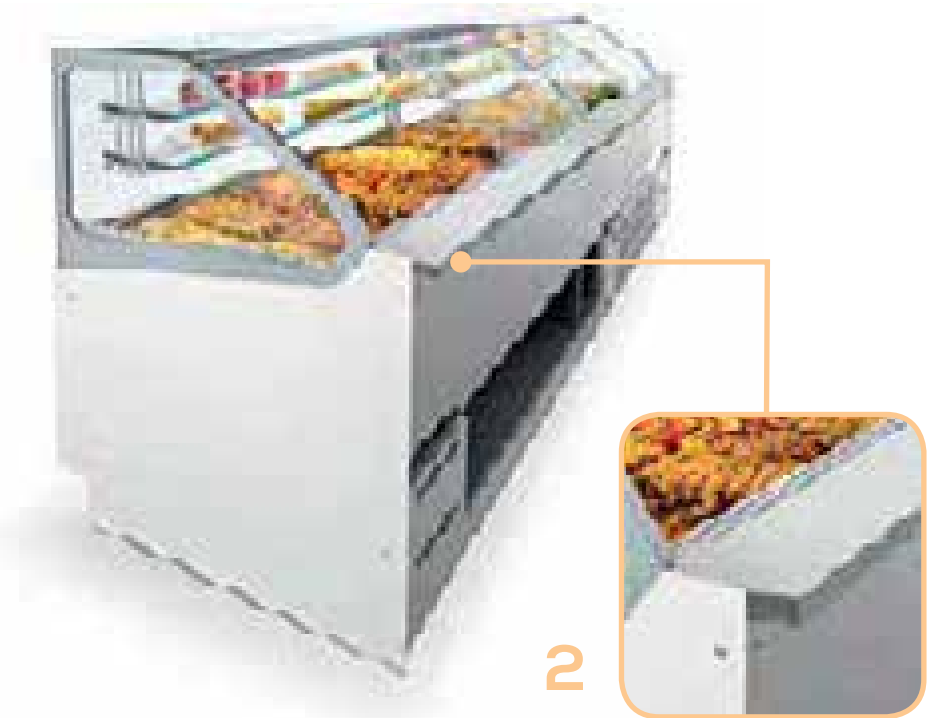

- 3. RAISABLE DISPLAY TOP**
 The 812mm / 31.97"-deep refrigerated display top is made of white glass with resistant screen-printing to perform the dry heat function. The top is raisable by means of gas pistons to access the evaporator and fan area (Cold Snack - Dry Heat; Dry Heat).

PIANO ESPOSITIVO SOLLEVABILE
 Il piano espositivo refrigerato profondo 812 mm è in vetro bianco con serigrafia resistiva per svolgere la funzione caldo secco. Il piano è sollevabile per mezzo di pistoni a gas per accedere alla zona dell'evaporatore e delle ventole (Snack Freddo - Caldo Secco; Caldo Secco).

PLAN D'EXPOSITION SOULEVABLE
 Le plan d'exposition réfrigéré de 812 mm de profondeur est en verre blanc à sérigraphie résistive pour assurer la fonction de chaleur sèche. Le plan est soulevable au moyen de pistons à gaz pour accéder à la zone de l'évaporateur et des ventilateurs (Snack Froids - Chaleur Sèche; Chaleur Sèche).

ANHEBBARE AUSSTELLUNGSFLÄCHE
 Die 812 mm tiefe gekühlte Ausstellungsfläche ist aus weißem Glas mit aufgedrucktem Widerstand für die Funktion der trockenen Wärme. Die Fläche lässt sich mittels Gaskolben anheben, um den Verdampfer und das Gebläse freizulegen (Kalter Snack - Trocken Warm; Trocken Warm).

SUPERFICIE DE EXPOSICIÓN ELEVABLE
 Superficie refrigerada de exposición, con una profundidad de 812 mm y de cristal blanco, con serigrafía resistiva para realizar la función de calor seco. La superficie se puede elevar mediante unos pistones de gas para acceder a la zona del evaporador y de los ventiladores (Snack Frio - Calor Seco; Calor Seco).



Technical data - Sections

DATI TECNICI - SEZIONI / DONNÉES TECHNIQUES - SECTIONS / TECHNISCHE DATEN - QUERSCHNITTE / DATOS TÉCNICOS - SECCIONES

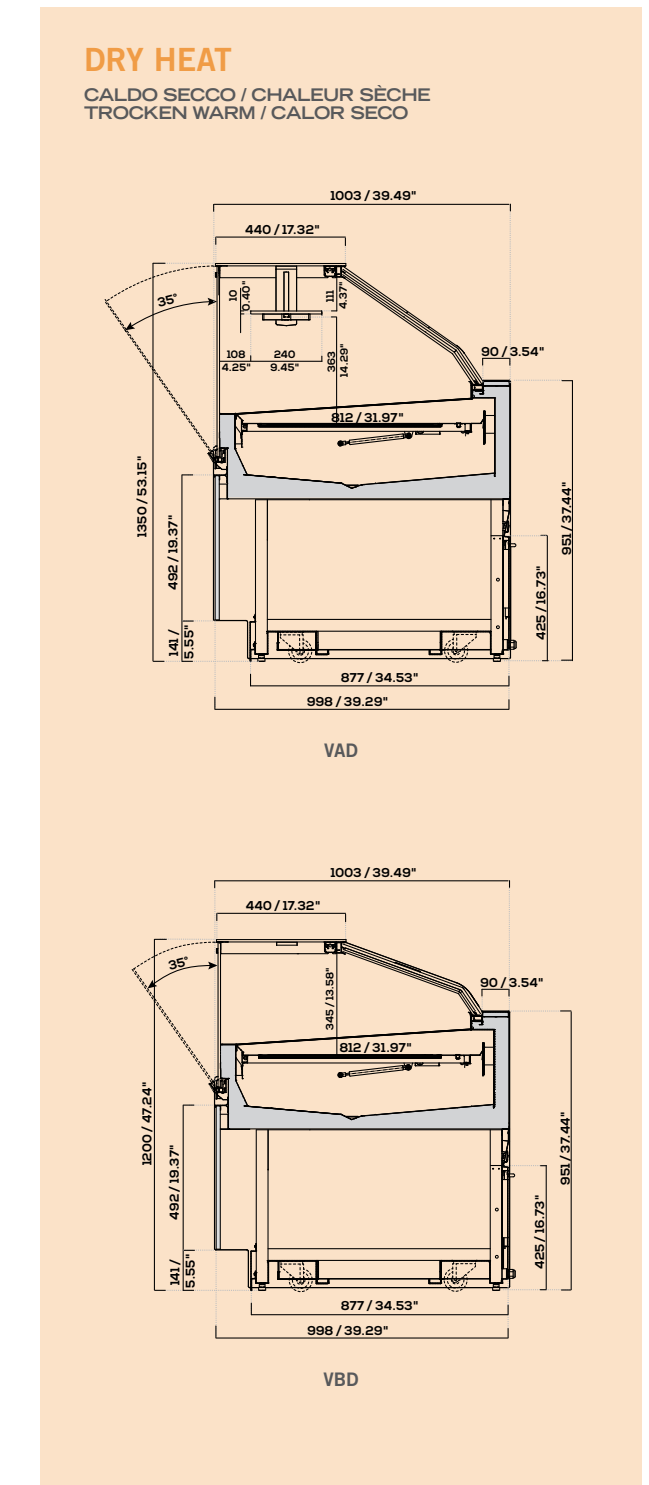
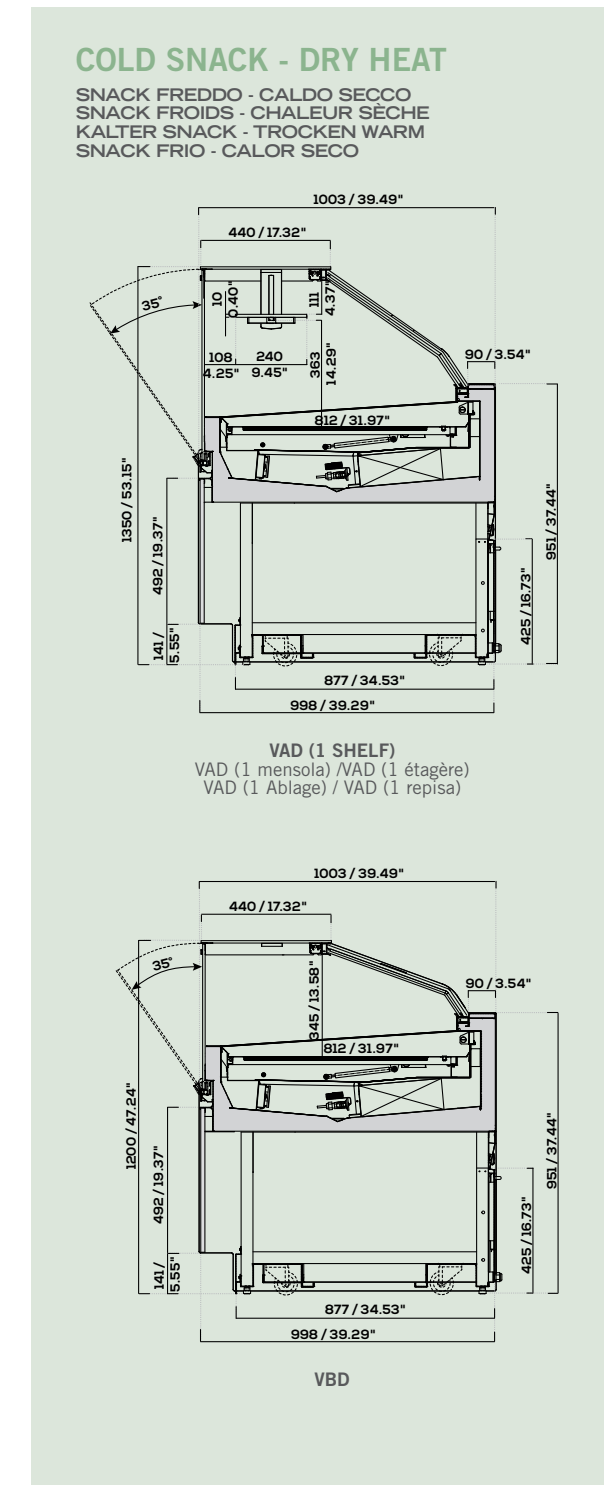
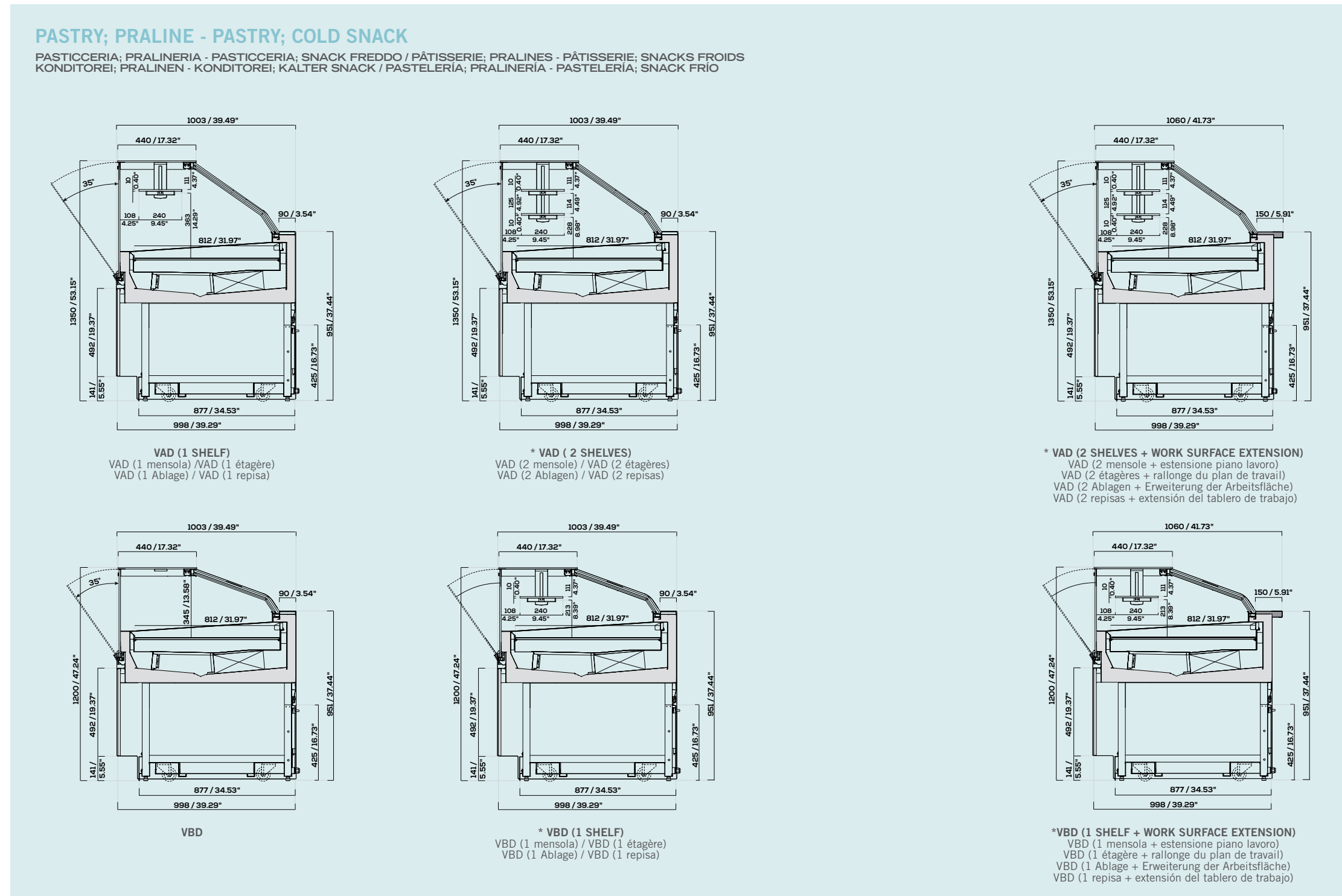
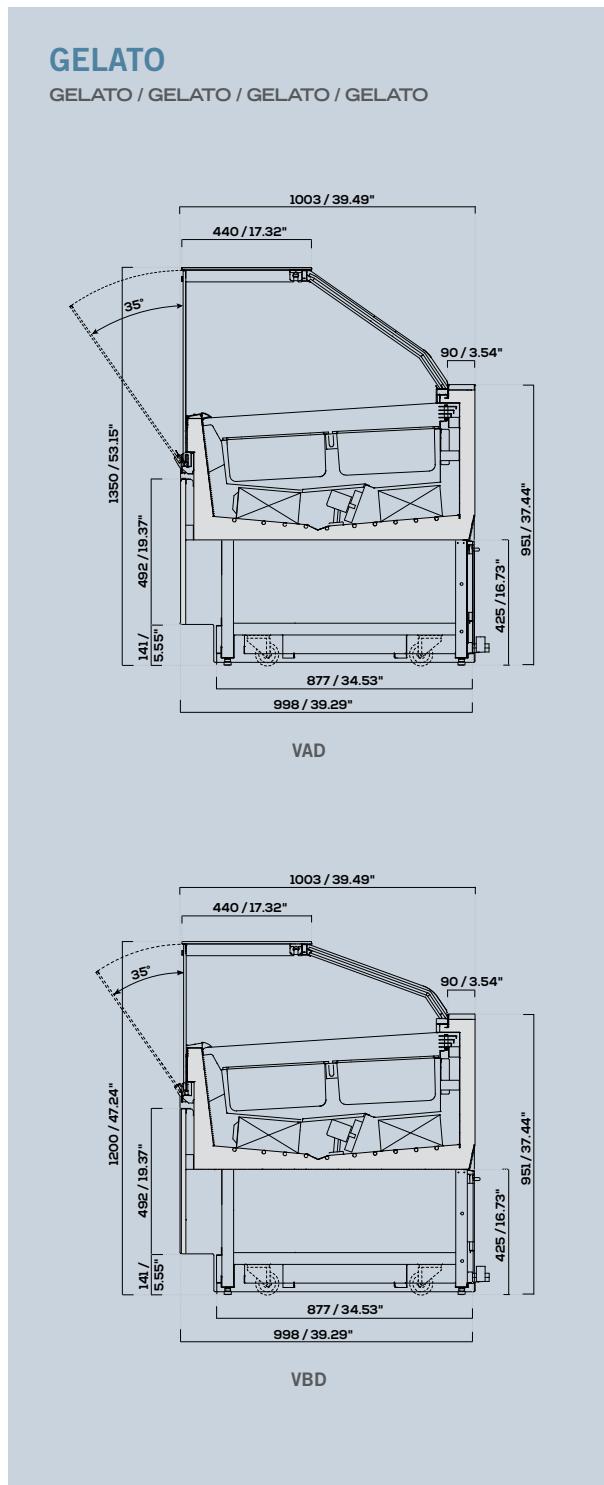

VAD:
High straight glasses
Vetri alti dritti
Vitres hautes droites
Hohe gerade Scheiben
Vidrios altos rectos

VBD:
Low straight glasses
Vetri bassi dritti
Vitres basses droites
Niedrige gerade Scheiben
Vidrios bajos rectos

Applications / Servizi	Units / Moduli		
	1125	1625	2125
Gelato / Gelato	VAD, VBD	VAD, VBD	VAD, VBD
Pastry; Praline; Cold Snack / Pasticceria; Praline; Snack Freddo	VAD, VBD	VAD, VBD	VAD, VBD
Pastry refrigerated shelves / Pasticceria mensole refrigerate	VAD	VAD	VAD
Cold snack - Dry heat / Snack freddo - Caldo secco	VAD, VBD	VAD, VBD	
Dry heat / Caldo secco	VAD, VBD	VAD, VBD	

* Optional:
1. In the SAM80 pastry with high straight glass (VAD) frame, 2nd shelf
2. In the SAM80 pastry with low straight glass (VBD) Frame, 1 shelf
3. Work surface extension

* Optional:
1. Nella SAM80 pasticceria con castello vetri alti dritti (VAD), 2^a mensola
2. Nella SAM80 pasticceria con castello vetri bassi dritti (VBD), 1 mensola
3. Estensione piano lavoro

* En option:
1. Dans la SAM80 pâtisserie avec structure en vitres hautes droites (VAD), 2^{ème} étagère
2. Dans la SAM80 pâtisserie avec structure en vitres basses droites (VBD), 1 étagère
3. Rallonge du plan de travail

* Sonderausstattung:
1. Bei SAM80 konditorei mit Glasregal mit hohen Geraden scheiben (VAD)
2. Ablage
2. Bei SAM80 konditorei mit Glasregal mit niedrigen Geraden scheiben (VBD), 1 Ablage
3. Erweiterung Der Arbeitsfläche

* Opcional:
1. En la SAM80 pastelería con campana de cristal vidrios altos rectos (VAD), 2^a repisa
2. En la SAM80 pastelería con campana de cristal vidrios bajos rectos (VBD), 1 repisa
3. Extensión del tablero de trabajo

SAM80 HAS BEEN DESIGNED BY IFI RESEARCH AND DEVELOPMENT DEPARTMENT. SAM80 È UN PROGETTO DEL DIPARTIMENTO RICERCA E SVILUPPO IFI.

IFI RESERVES THE RIGHT TO MAKE MODIFICATIONS TO THE PRODUCTS SHOWN IN THIS CATALOGUE AT ANY TIME WITHOUT PRIOR NOTICE. THE FINISHINGS SHOWN IN THIS CATALOGUE ARE APPROXIMATE, AS A PRINTED REPRODUCTION CAUSES INEVITABLE COLOUR DIFFERENCES.

IFI si riserva il diritto di apportare modifiche ai prodotti illustrati in questo catalogo, in qualunque momento senza l'obbligo di preavviso. Le finiture riprodotte in questo catalogo sono indicative per le inevitabili differenze dovute alla riproduzione tipografica.

IFI se réserve le droit de modifier les produits de ce catalogue à n'importe quel moment sans obligation de préavis. Les finitions montrées dans ce catalogue sont indicatives à cause des différences en couleur inévitables dues à la reproduction typographique.

IFI hält sich das Recht vor, zu jeder Zeit, die Produkte ohne Vorankündigung abzuändern. Wegen der unvermeidlichen Farbenverschiedenheiten, die von der typographischen Reproduktion geschaffen werden, sind die Feinbearbeitungen in diesem Katalog annähernd.

IFI se reserva el derecho de modificar los productos en cualquier momento sin previo aviso. Los acabados reproducidos en este catálogo son exactos debido a las normales variaciones tipográficas.



ADIMEMBER



Main Partner



IFI s.p.a.
Strada Selva Grossa 28/30
61010 TAVULLIA (PU) - Italy
Tel. +39 0721 20021
Fax +39 0721 201773
ifi.it - info@ifi.it - export@ifi.it

THE CATALOGUE HAS BEEN PRODUCED THROUGH THE COLLABORATION OF:
Il catalogo è stato realizzato con la collaborazione di:

- Art Direction
Studiopieri Web & Graphic Agency
IFI Marketing Department

- Photo
Amati Bacciardi

- Post production
Studiopieri Web & Graphic Agency

© COPYRIGHT IFI S.p.A.
Tavullia (PU), Italia 2015, 2017
- ALL RIGHTS RESERVED
- Tutti i diritti riservati

01/2017

PRODUCTS MAY BE PROTECTED BY PATENT AND/OR DESIGN
I prodotti possono essere tutelati da brevetto e/o da design
Les produits peuvent être protégés par brevet et/ou sur leur design
Die Produkte können vom Patent und/oder Design geschützt sein
Los productos pueden ser protegidos por patente y por diseño

ifi.it

#ifi1962



INDUSTRIEIFI®